

Mistral 250

DT-M-250

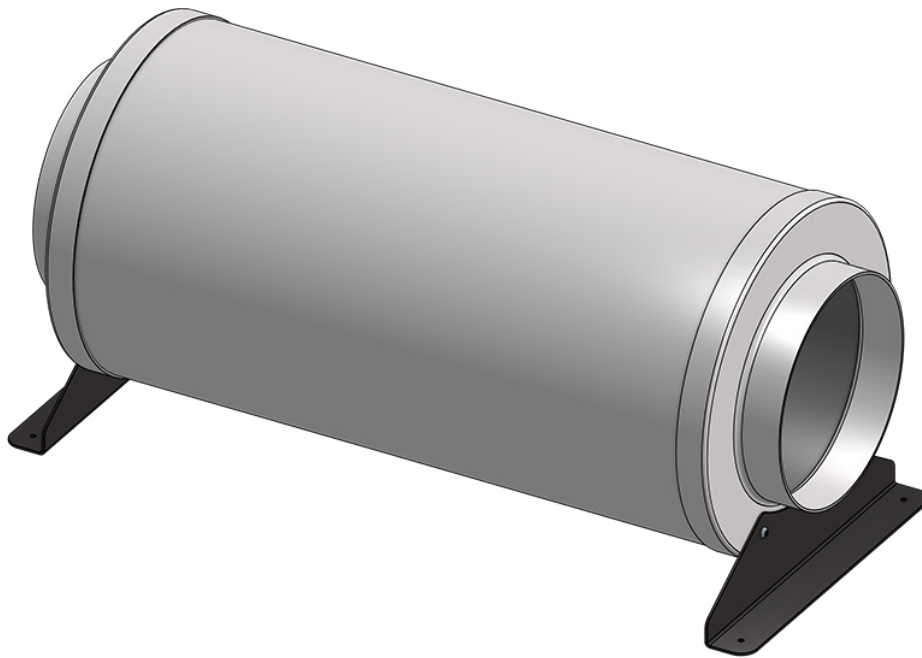

Mistral 250

MISTRAL 250 [DT-M-250] - SILENCED INLINE 250MM FAN MODULE WITH BRUSHLESS EC MOTOR AND MISTRAL COMMANDER INTERFACE

DT Mistral 250 is a silenced inline 150mm fan module with an advanced brushless EC motor and featuring a special interface to enable full monitoring and control by the Mistral Commander. The DT-M-250 delivers up to 1700 cubic meters per hour of airflow.

The silenced Mistral-250 mounting plate includes isolation fittings to minimise vibration and is supplied with 6m of perforated acoustic ducting to ensure the quietest possible air movement solution.

The M-250 contains an advanced brushless EC Motor with Mistral Commander Interface. The interface enables full reporting of fan speed and accurate speed control between 0-100% of full output. This enables M-250 to only operate when required for maximum efficiency.

The M-250 delivers up to 1700 cubic meters per hour of airflow and is ideal for applications with a heat load up to 10000 BTU/hr.

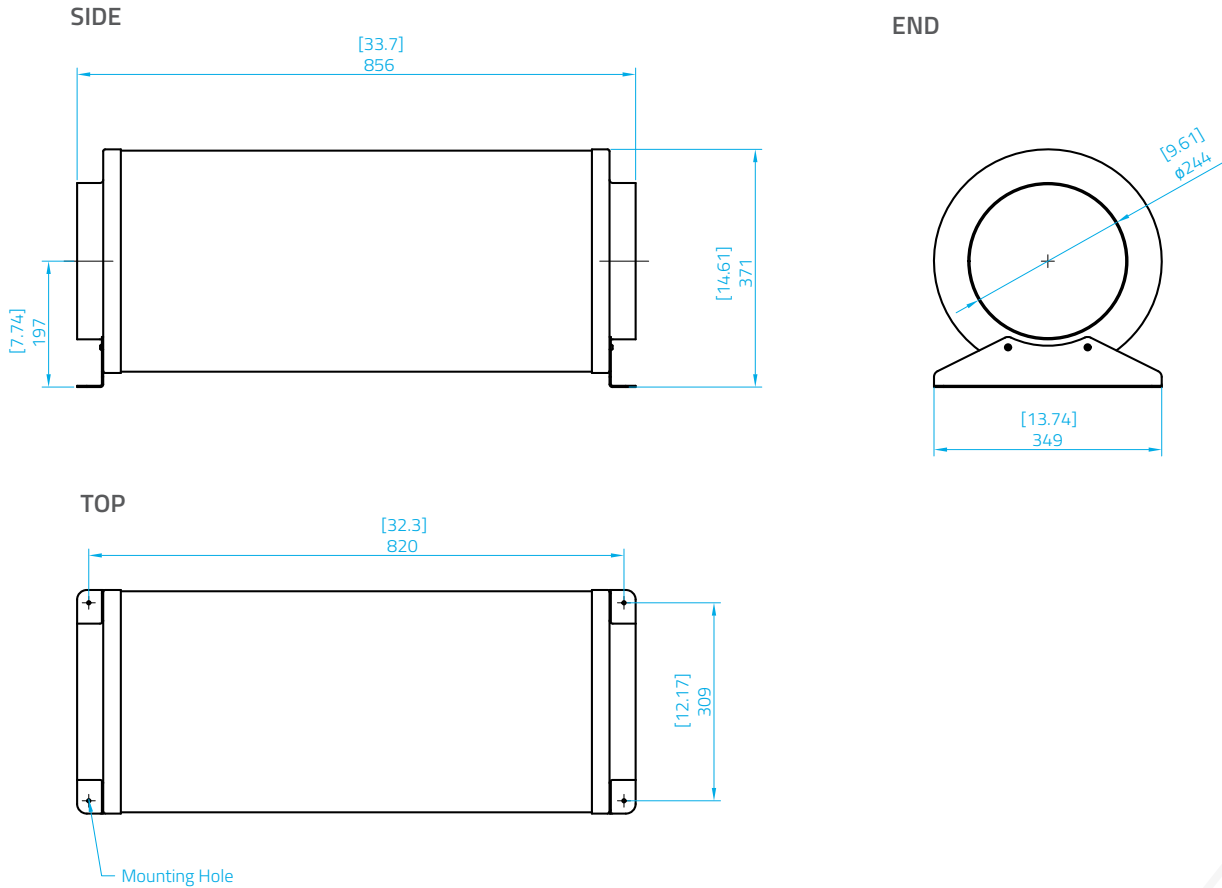

Mistral 250 - technical drawing

Display Technologies is a British brand specialising in advanced projector screens, mounting brackets and custom installation solutions. Their focus on the combination of technical performance and design for install, ensure that all DT products meet the needs of both the client and installer.

